



EASYAIR

Water-supplied, electrical or cold air curtain

Water-supplied, electrical or cold air curtain for retail or industrial applications. Output from 6 to 39,3 kW.



For more information, downloads and videos, visit the Easyair page on our website



Product features

- Compact and modern design
- Silent operation
- Efficient EC motor
- Standard white finish in RAL 9016
- Simple installation
- Low maintenance
- Optional: version in RAL 7016 (dark grey)

Keep cold and contaminated air outside

Due to its broad range, the EASYAIR air curtain can be used in any sort of open entrance, such as in shops, supermarkets, builder's merchants, offices and hospitals. The air curtains are available as water-supplied and electric. Ambient air curtains without a heating source are also available.

The EASYAIR air curtains are suitable for an installation height of up to 3.7 meters and are available in widths of 1, 1.5 and 2 meters. The air curtain without a heating source is even suitable for an installation height of up to 4.7 meters. The air curtains can be mounted both horizontally and vertically with the optional mounting brackets.

The air curtains can be connected to each other to create a wider air curtain (up to 8 pieces per controller).

The housing of the EASYAIR consists of a double coating (galvanization + powder coating) and offers long-term protection against corrosion.

Suitable for use in shops, offices, hospitals and factories.

EASYAIR air curtains are equipped with a speed controlled low noise EC-fan. Advantages:

- The highest efficiency in case of speedcontrol
- Up to 50% energy saving in case of partial load
- Almost completely linearly adjustable
- Long lifetime
- Low noise level
- Integrated electronic thermal protection

Dimensions

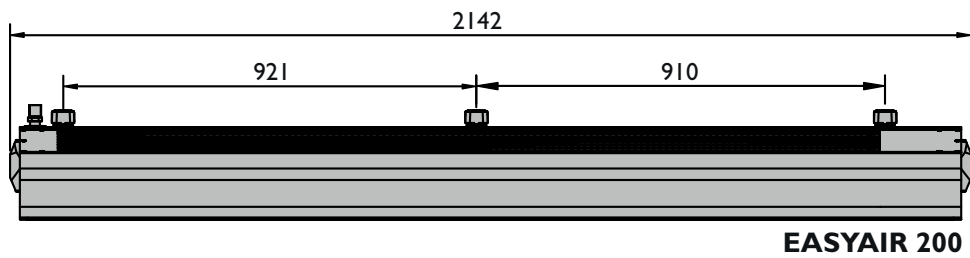
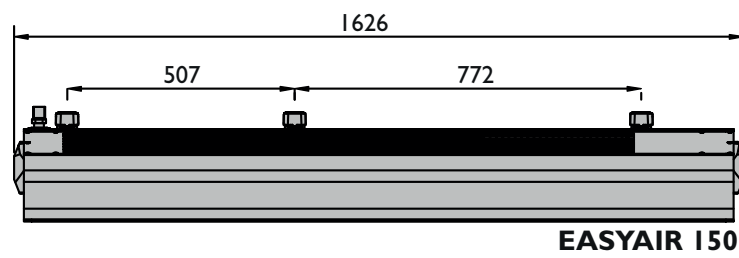
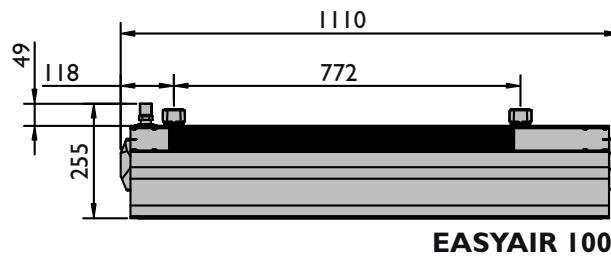
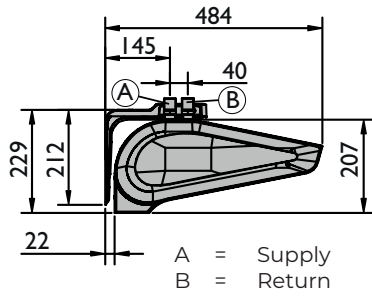

Technical information

Type		Water-supplied air curtain			Electric air curtain			Ambient air curtain		
		W100	W150	W200	E100	E150	E200	C100	C150	C200
Maximum door width (1 unit)	m	1	1,5	2	1	1,5	2	1	1,5	2
Maximum door height (vertical air stream)**	m	3,7			3,7			4,7		
Maximum air flow	m ³ /h	1850	3100	4400	1850	3150	4500	1950	3200	4600
Heating power range*	kW	4-17	10-32	17-47	2-6 or 4-6	4-12 or 8-12	6-15 or 9-15	-		
Maximum temperature heat exchanger	°C	95			-			-		
Maximum operating pressure	MPa	1,6			-			-		
Water volume	dm ³	1,6	2,6	3,6	-			-		
Number of rows heat exchanger	st	2			-			-		
Supply voltage	V/ph/Hz	~ 230/1/50			~230/1/50 for 2kW ~400/3/50 for 2/4/6kW	~400/3/50		~ 230/1/50		
Power electric heating coil	kW	-			2 or 4	4 or 8	6 or 9	-		
Current electric heating coil	A	-			max.9	6/11,3/ max 17,3	8,5/12,9/ max 21,4	-		
Motor power	kW	0,2	0,3	0,45	0,2	0,3	0,45	0,2	0,3	0,45
Nominal current	A	1,1	1,3	1,9	1,1	1,3	1,9	1,1	1,3	1,9
Weight (without water)	kg	21,5	29	37,5	22	30,5	39	19	25,5	32,5
Protection class	IP	20								
Colour		Casing: RAL 9016, Exhaust grille: RAL 9022								

Fan speed	Noise level	Easyair W100-200			Easyair E100-200			Easyair C100-200		
		1m	1,5m	2m	1m	1,5m	2m	1m	1,5m	2m
I	dB(A)***	52	53	56	49	51	55	53	54	57
II	dB(A)***	55	58	61	51	56	59	59	62	61
III	dB(A)***	57	59	62	58	58	60	62	63	63

* available heating power in the control option configuration:

Easyair E100 2-6 kW or 4-6 kW

Easyair E150 4-12kW or 8-12kW

Easyair E200 6-15 kW or 9-15 kW

** air stream range depends on curtain operation speed

*** measurement conditions: semi-open space, horizontal installation on the wall, measurement performed 5 m away from the device

EASYAIR W - WATER-SUPPLIED AIR CURTAIN

Tz = water temperature at the inlet to the device

Tp = water temperature at the outlet from the device

Tp1 = air temperature at the inlet to the device

Tp2 = air temperature at the outlet from the device

Pg = heating power of the device

Qw = water flow

 Δp = pressure drop in the heat exchanger

Parameters		Easyair W100															
T_z/T_p [°C]		90/70				80/60				70/50				60/40			
T_{p1} [°C]		5	10	15	20	5	10	15	20	5	10	15	20	5	10	15	20
III/1850[m³/h]/57dB(A)*																	
P_g [kW]		17,7	16,3	14,9	13,5	14,8	13,3	11,9	10,5	11,6	10,2	8,7	7,0	8,0	5,1	4,3	3,5
T_{p2} [°C]		32,0	35,3	38,5	41,7	27,5	30,7	33,8	36,8	22,8	25,8	28,7	31,3	17,2	17,9	21,8	25,6
Q_w [m³/h]		0,8	0,7	0,7	0,6	0,7	0,6	0,5	0,5	0,5	0,5	0,4	0,3	0,4	0,2	0,2	0,2
Δp [kPa]		0,5	0,4	0,4	0,3	0,4	0,3	0,2	0,2	0,2	0,2	0,1	0,1	0,1	0,1	0,04	0,03
II/1350[m³/h]/55dB(A)*																	
P_g [kW]		15,0	13,8	12,6	11,4	12,5	11,3	10,1	8,8	9,8	8,5	7,2	4,7	5,4	4,6	3,9	3,2
T_{p2} [°C]		34,7	37,8	40,8	43,7	29,7	32,7	35,6	38,4	24,4	27,2	29,7	29,7	15,6	19,3	23,0	26,7
Q_w [m³/h]		0,7	0,6	0,6	0,5	0,6	0,5	0,4	0,9	0,4	0,4	0,3	0,2	0,2	0,2	0,2	0,1
Δp [kPa]		0,4	0,3	0,3	0,2	0,3	0,2	0,2	0,1	0,2	0,1	0,1	0,1	0,1	0,1	0,04	0,03
I/880[m³/h]/52dB(A)*																	
P_g [kW]		11,9	10,9	9,9	9,0	9,8	8,9	7,9	6,9	7,6	6,5	4,6	4,0	4,6	4,0	3,4	2,8
T_{p2} [°C]		38,5	41,3	44,0	46,7	32,8	35,5	38,0	40,4	26,5	28,8	28,6	31,9	18,0	21,5	24,9	28,4
Q_w [m³/h]		0,5	0,5	0,4	0,4	0,4	0,4	0,4	0,3	0,3	0,3	0,2	0,2	0,2	0,2	0,2	0,1
Δp [kPa]		0,2	0,2	0,2	0,1	0,2	0,1	0,1	0,1	0,1	0,1	0,1	0,0	0,1	0,04	0,03	0,02
Parameters		Easyair W150															
T_z/T_p [°C]		90/70				80/60				70/50				60/40			
T_{p1} [°C]		5	10	15	20	5	10	15	20	5	10	15	20	5	10	15	20
III/3100[m³/h]/59dB(A)*																	
P_g [kW]		31,7	29,3	26,9	24,5	26,9	24,5	22,1	19,8	22,0	19,6	17,3	14,9	17,0	14,5	12,1	9,5
T_{p2} [°C]		33,9	37,2	40,4	43,6	29,5	32,7	35,9	39,0	25,1	28,2	31,3	34,3	20,5	23,5	26,4	29,1
Q_w [m³/h]		1,4	1,3	1,2	1,1	1,2	1,1	1,0	0,9	1,0	0,9	0,8	0,7	0,7	0,6	0,5	0,4
Δp [kPa]		2,1	1,8	1,6	1,3	1,6	1,4	1,2	0,9	1,2	1,0	0,8	0,6	0,8	0,6	0,4	0,3
II/2050[m³/h]/58dB(A)*																	
P_g [kW]		26,5	24,5	22,5	20,5	22,5	20,5	18,5	16,6	18,5	16,5	14,4	12,4	14,2	12,1	10,0	7,7
T_{p2} [°C]		36,9	40,0	43,0	46,0	32,1	35,1	38,1	41,0	27,2	30,1	33,0	35,7	22,1	24,8	27,5	29,7
Q_w [m³/h]		1,2	1,1	1,0	0,9	1,0	0,9	0,8	0,7	0,8	0,7	0,6	0,5	0,6	0,5	0,4	0,3
Δp [kPa]		1,5	1,3	1,2	1,0	1,2	1,0	0,8	0,7	0,9	0,7	0,6	0,4	0,6	0,4	0,3	0,2
I/1420[m³/h]/53dB(A)*																	
P_g [kW]		21,6	19,9	18,3	16,7	18,3	16,7	15,1	13,5	15,0	13,4	11,7	10,1	11,5	9,8	8,0	4,8
T_{p2} [°C]		40,4	43,3	46,1	48,9	35,1	37,9	40,6	43,3	29,6	32,3	34,9	37,4	23,9	26,3	28,5	28,3
Q_w [m³/h]		1,0	0,9	0,8	0,7	0,8	0,7	0,7	0,6	0,7	0,6	0,5	0,4	0,5	0,4	0,4	0,2
Δp [kPa]		1,1	0,9	0,8	0,7	0,8	0,7	0,6	0,5	0,6	0,5	0,4	0,3	0,4	0,3	0,2	0,1

Parameters		Easyair W200															
T_2/T_p [°C]		90/70				80/60				70/50				60/40			
T_{p1} [°C]		5	10	15	20	5	10	15	20	5	10	15	20	5	10	15	20
III/4400[m ³ /h]/62dB(A)*																	
P_g [kW]		46,9	42,7	39,3	35,9	39,4	36,0	32,6	29,3	32,6	29,2	25,8	22,5	25,7	22,3	18,9	15,4
T_{p2} [°C]		34,6	37,9	41,1	44,3	30,3	33,5	36,7	39,8	25,9	29,1	32,2	35,2	21,5	24,5	27,5	30,4
Q_w [m ³ /h]		2,0	1,9	1,7	1,6	1,7	1,6	1,4	1,3	1,4	1,3	1,1	1,0	1,1	1,0	0,8	0,7
Δp [kPa]		5,6	4,9	4,2	3,6	4,3	3,7	3,1	2,6	3,2	2,6	2,1	1,7	2,2	1,7	1,3	0,9
II/3150[m ³ /h]/61dB(A)*																	
P_g [kW]		40,9	37,9	34,8	31,9	35,0	31,9	28,9	26,0	28,9	25,9	22,9	20,0	22,8	19,8	16,7	13,7
T_{p2} [°C]		36,6	39,8	42,9	46,0	32,0	35,1	38,2	41,2	27,4	30,4	33,4	36,3	22,6	25,6	28,4	31,1
Q_w [m ³ /h]		1,8	1,7	1,5	1,4	1,5	1,4	1,3	1,1	1,3	1,1	1,0	0,9	1,0	0,9	0,7	0,6
Δp [kPa]		4,5	3,9	3,4	2,9	3,5	3,0	2,5	2,1	2,6	2,1	1,7	1,4	1,8	1,4	1,0	0,7
I/2050[m ³ /h]/56dB(A)*																	
P_g [kW]		34,0	31,4	28,9	26,4	29,0	26,5	24,0	21,6	24,1	21,6	19,1	16,6	19,0	16,4	13,9	11,3
T_{p2} [°C]		39,9	42,8	45,8	48,6	34,8	37,7	40,6	43,3	29,7	32,5	35,3	37,9	24,5	27,2	29,8	32,2
Q_w [m ³ /h]		1,5	1,4	1,3	1,2	1,3	1,2	1,1	1,0	1,1	1,0	0,8	0,7	0,8	0,7	0,6	0,5
Δp [kPa]		3,2	2,8	2,4	2,1	2,5	2,2	1,8	1,5	1,9	1,6	1,2	1,0	1,3	1,0	0,7	0,5

EASYAIR E - ELECTRIC AIR CURTAIN

T_{p1} = air temperature at the inlet to the device

T_{p2} = air temperature at the outlet from the device

P_g = heating power of the device

Parameters	Easyair E100				Easyair E150				Easyair E200			
T_{p1} [°C]	5	10	15	20	5	10	15	20	5	10	15	20
III/1850[m ³ /h]/59dB(A)*												
P_g [kW]	2/4/6	2/4/6	2/4/6	2/4/6	8/12	8/12	8/12	8/12	10/15	10/15	10/15	10/15
T_{p2} [°C]	8/11/15	13/16/20	18/21/25	23/26/30	12/15	17/20	22/25	27/30	10/14	15/19	20/24	25/29
II/1400[m ³ /h]/48dB(A)*												
P_g [kW]	2/4/6	2/4/6	2/4/6	2/4/6	8/12	8/12	8/12	8/12	10/15	10/15	10/15	10/15
T_{p2} [°C]	9/12/16	14/17/21	19/22/26	24/27/31	14/19	19/24	24/29	29/34	12/16	17/21	22/26	27/31
I/920[m ³ /h]/44dB(A)*												
P_g [kW]	2/4/6	2/4/6	2/4/6	2/4/6	8/12	8/12	8/12	8/12	10/15	10/15	10/15	10/15
T_{p2} [°C]	11/16/21	16/21/26	21/26/31	26/31/36	19/26	24/31	29/36	34/41	15/21	20/26	25/31	30/36

EASYAIR C - AMBIENT AIR CURTAIN

Parameters	EASYAIR C100			EASYAIR C150			EASYAIR C200		
Fan speed	III	II	I	III	II	I	III	II	I
Q_p [m ³ /h]	1950	1500	1050	3200	2250	1500	4600	3400	2340
Noise level [dB(A)]	62	59	53	63	62	54	63	61	57

Accessories



HMI-EC Controller
(0699150)



Door sensor
(0699151)



Valve with actuator
(0699152)



Mounting brackets
(0699153/0699154)



Flexible hoses
(0699155)

Assembly/location suggestions

HORIZONTAL INSTALLATION

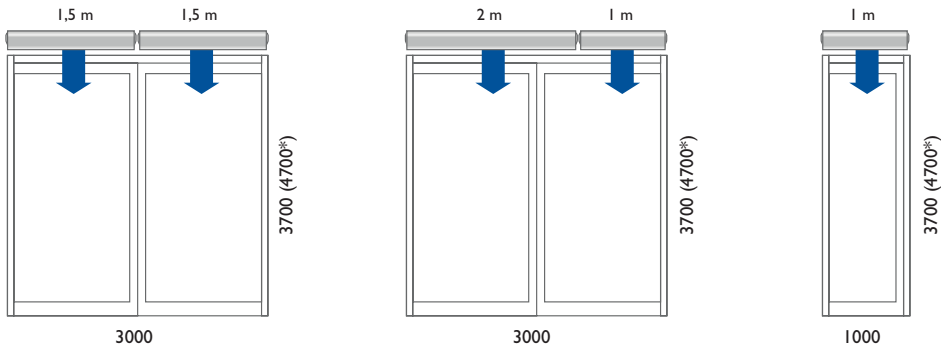

VERTICAL INSTALLATION

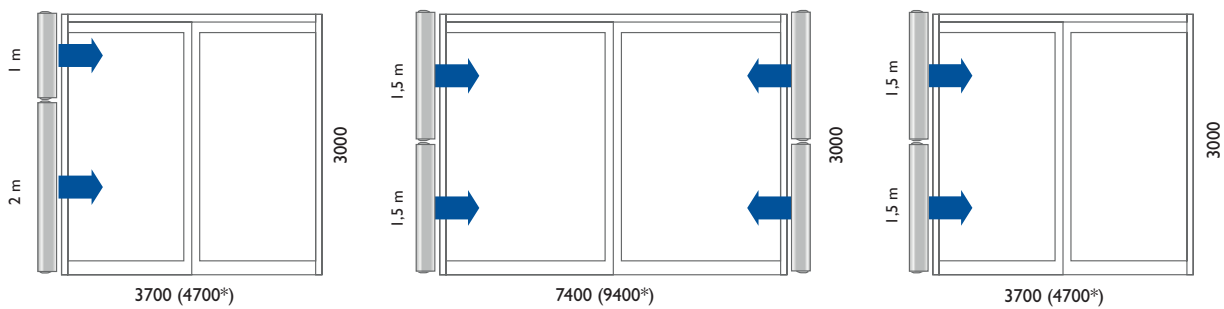

* Easyair C

Note: The Easyair E cannot be installed vertically.

Controls

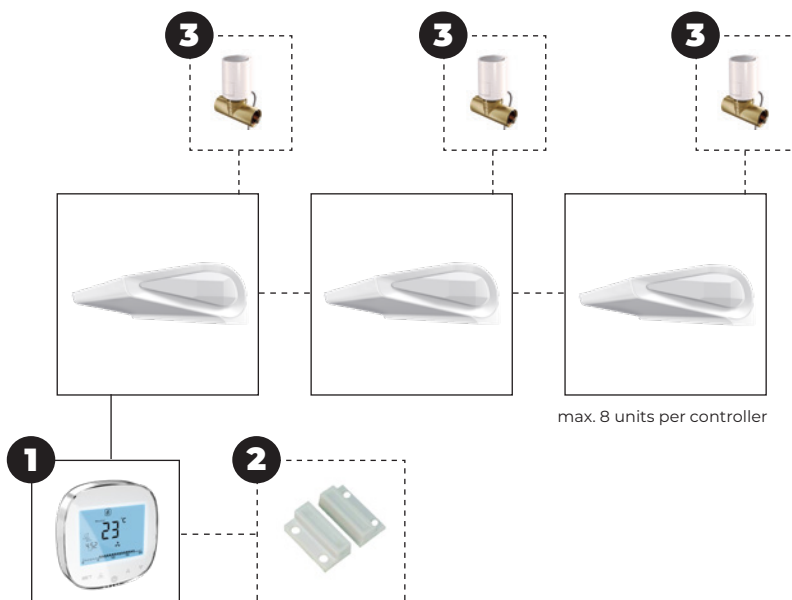

Control combination options

Easyair	+	1		
Easyair	+	1	+	2
Easyair	+	1	+	3
Easyair	+	1	+	2 + 3

See price list for description and code numbers of the relevant items